

REVISION			
REV	CR	DATE	CM APPROVED
0-1	22752	06/19/14	MS

**TEST REPORT  
FOR THE  
2J6026M  
ANTENNA**



**AUTHOR(S):**

**Jan Larsen**

IRIDIUM DOCUMENT ID

**RPT-05400-IR**

**DOCUMENT APPROVALS**

Note: The following record of approvals is for the current revision only

<b>REQUIRED APPROVALS</b>		
<b>Title</b>	<b>Name</b>	<b>CM Confirmation of Approval</b>
Author	Jan Larsen	MS
IPT Lead	Tracy Woodward	MS

## Table of Contents

<b>1. Test Purpose .....</b>	<b>5</b>
<b>2. Test Configuration .....</b>	<b>6</b>
2.1 Test Equipment – Voice and Data .....	6
2.2 General Test Configurations .....	7
<b>3. Description of Testing.....</b>	<b>8</b>
3.1 Voice Mode Testing and Power Control.....	8
3.2 50K Put File Transfer Protocol Testing .....	9
3.3 SV-ISU Link Margin .....	9
<b>4. Test Results.....</b>	<b>10</b>
4.1 Voice Mode Call Performance Testing.....	10
4.2 Data Mode Performance Testing .....	12
4.2.1 Downlink Margin Using Analysis Type One.....	12
4.2.2 Downlink Margin Using Analysis Type Two.....	13
4.3 Power Control Efficiency .....	15
4.3.1 Power Control Capacity Factor.....	15
4.3.2 Power Control Link Quality Index and Power Control.....	18
<b>5. Test Summary .....</b>	<b>22</b>
5.1 Voice Calls .....	22
5.2 50K FTP Upload.....	22
5.2.1 Downlink Margin.....	22

## List of Pictures

Picture 2-1: 2J6026M Antenna.....	6
-----------------------------------	---

## List of Tables

Table 1-1: Performance Characterization Tests.....	5
Table 2.1-1: 2J6026M Antenna Lab Equipment.....	6
Table 2.1-2: Aero Baseline Lab Equipment .....	6
Table 4.1-1: 2J6026M Antenna 180 second I2P Voice Test Results.....	10
Table 4.2-1: 2J6026M Antenna, Dialup 50k FTP Upload Testing .....	12

## List of Figures

Figure 2.2-1: Test Configuration .....	7
Figure 3.1-1: Voice Dialer Test Configuration.....	8
Figure 3.2-1: Data Dialer Test Configuration.....	9
Figure 4.1-1: 2J6026M Antenna, Percentage of Time, 180 sec I2P .....	10
Figure 4.1-2: 2J6026M Antenna, Call Setup Rate vs. Elevation Angle.....	11
Figure 4.2.1-1: 2J6026M Antenna, Downlink Margin .....	12
Figure 4.2.1-2: Aero Baseline Antenna, Downlink Margin.....	13
Figure 4.2.2-1: 2J6026M Antenna, per Beam Downlink Margin .....	13
Figure 4.2.2-2: Aero Baseline Antenna, per Beam Downlink Margin .....	14
Figure 4.3.1-1: 2J6026M Antenna, Capacity Factor during 180 second I2P Voice calls .....	15
Figure 4.3.1-2: 2J6026M Antenna, Downlink, Back Off Power Percentage of Time .....	16
Figure 4.3.1-3: 2J6026M Antenna, Uplink, Back Off Power Percentage of Time .....	17
Figure 4.3.2-1: 2J6026M Antenna, LQI and Power Control 180 Sec I2P .....	18
Figure 4.3.2-2: Aero Baseline Antenna LQI and Power Control 180 Sec I2P .....	19
Figure 4.3.2-3: 2J6026M Antenna, DTOA/DFOA, 180 Sec I2P.....	20
Figure 4.3.2-4: Aero Baseline Antenna, DTOA/DFOA, 180 Sec I2P .....	21

## 1. TEST PURPOSE

The purpose of the test was to characterize the On-Orbit Iridium performance of the 2J6026M Iridium Antenna. The Iridium Technical Support Center (TSC) received one antenna for testing purposes. The antenna was tested with a 9522B. A baseline test was performed in parallel using an Iridium approved Aero Fixed Mast Antenna. The performance characterization tests are shown in the following table.

Performance Characterized	Configuration	Duration
Voice	180 Second ISU-PSTN Voice Calls	3 Days
Data	FTP 50k Uploads	4 Days
Downlink Margin	Dialup 50K Uploads	24 Continuous Hours of FTP Uploads
Power Control	ISU-PSTN Voice Calls	24 Continuous Hours of 180 second calls

*Table 1-1: Performance Characterization Tests*

## 2. TEST CONFIGURATION

There are multiple lab configurations available for testing at the TSC. Below are a picture of the 2J6026M antenna and a brief description of the equipment used for testing it.



Picture 2-1: 2J6026M Antenna

### 2.1 Test Equipment – Voice and Data

Test Equipment List - UUT
Antenna: 2J6026M
Phone Type: 9522B
IMEI: 300025010703540
SW Version: ST10001
Test station: 106
Antenna Drop:45
Total Cable Loss: -1.8 dB

Table 2.1-1: 2J6026M Antenna Lab Equipment

Test Equipment List - Baseline
Antenna: AT1621-142W-TNCF-000-00-00-NM
Phone Type: 9522B
IMEI: 300025010509820
SW Version: ST10001
Test station:104
Antenna Drop: 18
Total Cable Loss: -1.8 dB

Table 2.1-2: Aero Baseline Lab Equipment

## 2.2 General Test Configurations

The antenna was mounted on a standard antenna stand connected to the rooftop antenna array at the TSC. A low loss cable routes from the antenna to the lab. Within the lab the cable connects to an LBT. The LBT then interfaces to the auto-dialer. The autodialer produces metrics and logs which are used for analysis. Figure 2.2-1 is a diagram of the test configuration.

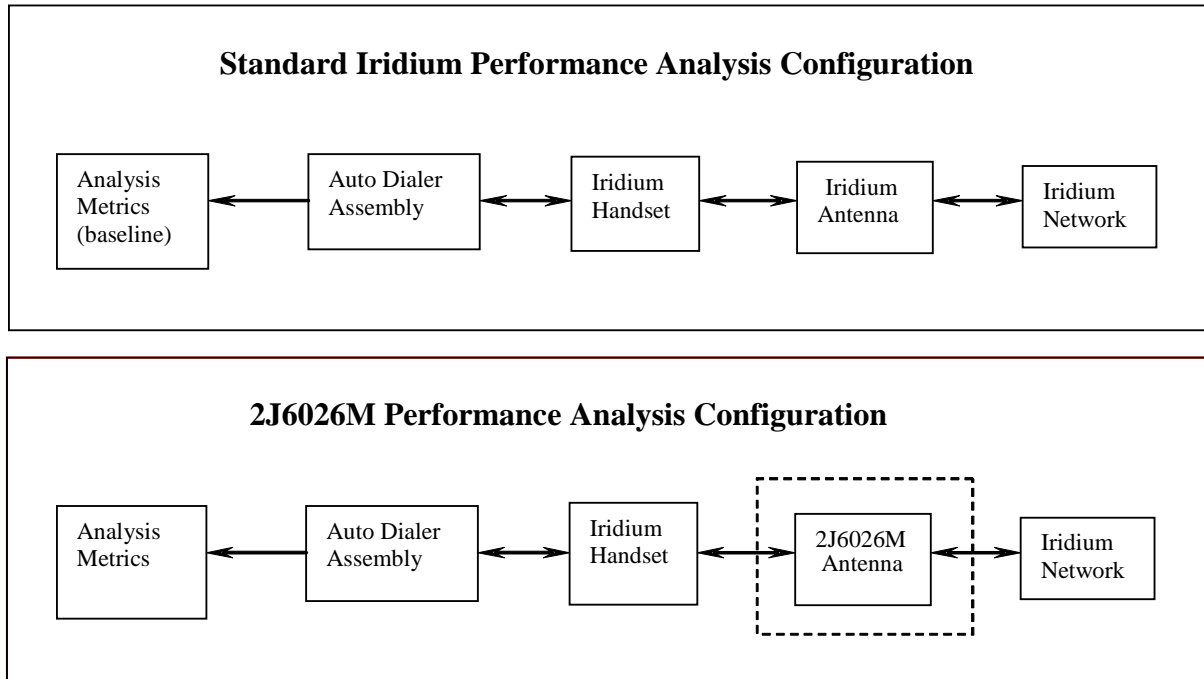

Figure 2.2-1: Test Configuration

### 3. DESCRIPTION OF TESTING

#### 3.1 Voice Mode Testing and Power Control

Voice Mode call performance testing involves making consecutive voice mode calls to the IST Gateway (i.e. ISU-PSTN). These calls are 180 seconds and they accentuate the performance of the call setup and call drop rates. These calls are terminated (answered) by the Digital Answering System (DAS) in the Ericsson Switch at the IST Gateway. The auto-dialer is configured to log binary data and write a statistics file that is used for analysis. The time between successive calls is 20 seconds.

For the purposes of this test, the voice mode is used to gather telephony performance and additionally power control information. During the voice testing, the auto-dialers record the binary logfile information from the LBTs. This data contains the raw SV-ISU power control values throughout the test. This data is post processed to determine the power control efficiency. The data is compared to baseline data to determine if the antenna under test produced a nominal profile as compared to the standard lab performance monitoring antenna during the same time frame. The voice mode configuration is shown in the following figure.

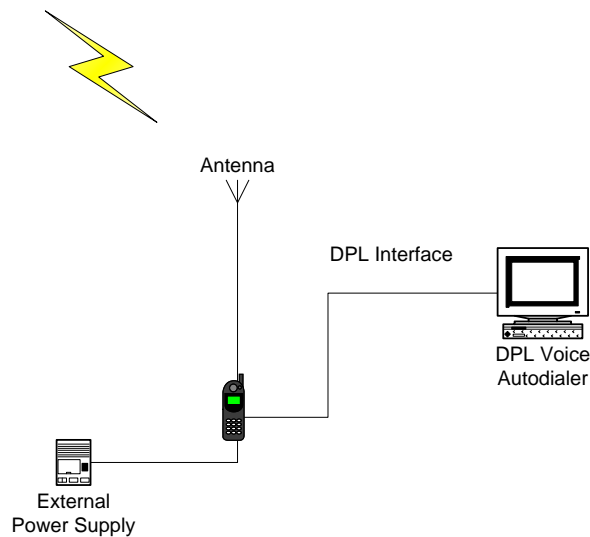
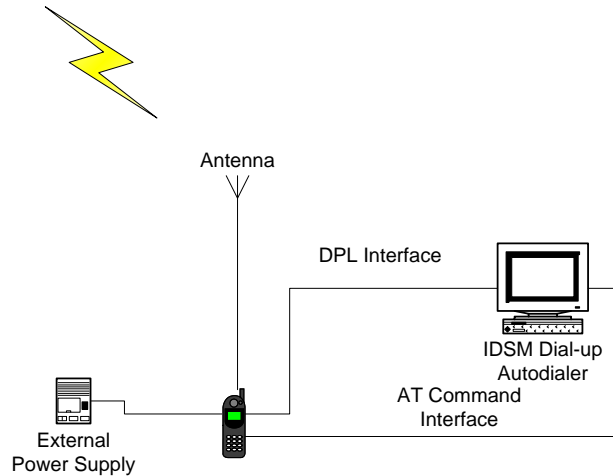

*Figure 3.1-1: Voice Dialer Test Configuration*



### 3.2 50K Put File Transfer Protocol Testing

Data Mode testing involves making consecutive data calls to an FTP server at TSC. Each call attempts to transfer a 50K file via the FTP process. Successes are logged if the connection is made and the file is transferred. The data mode configuration is shown in the following figure.



*Figure 3.2-1: Data Dialer Test Configuration*

### 3.3 SV-ISU Link Margin

During the data testing, the auto-dialers record the binary logfile information from the LBT. This data contains the raw SV-ISU power measurement values throughout the test. This data is post processed to determine the SV-ISU link margin. The data is compared to baseline data to show its performance relative to the Aero Baseline Antenna.

#### 4. TEST RESULTS

The following sections detail each of the tests performed and the resulting data from those tests. Baseline dialer data gathered during the same time frame using the Aero Baseline antenna is included for each test.

##### 4.1 Voice Mode Call Performance Testing

The test consisted of 180 second calls being made to the IST Gateway. Table 4.1-1 contains the performance results for the antenna for the test duration.

180 Second I2P Voice Calls	Call Attempts	Call Setup Rate	Call Drop Rate	Avg Channel Assignment Time	Access Rate	Avg Access Time	Avg Setup Time
2J6026M Antenna	1112	97.39%	1.66%	4.69	97.57%	6.83	9.39
Aero Baseline Antenna	1112	98.47%	1.55%	4.64	98.56%	6.84	9.62

Table 4.1-1: 2J6026M Antenna 180 second I2P Voice Test Results

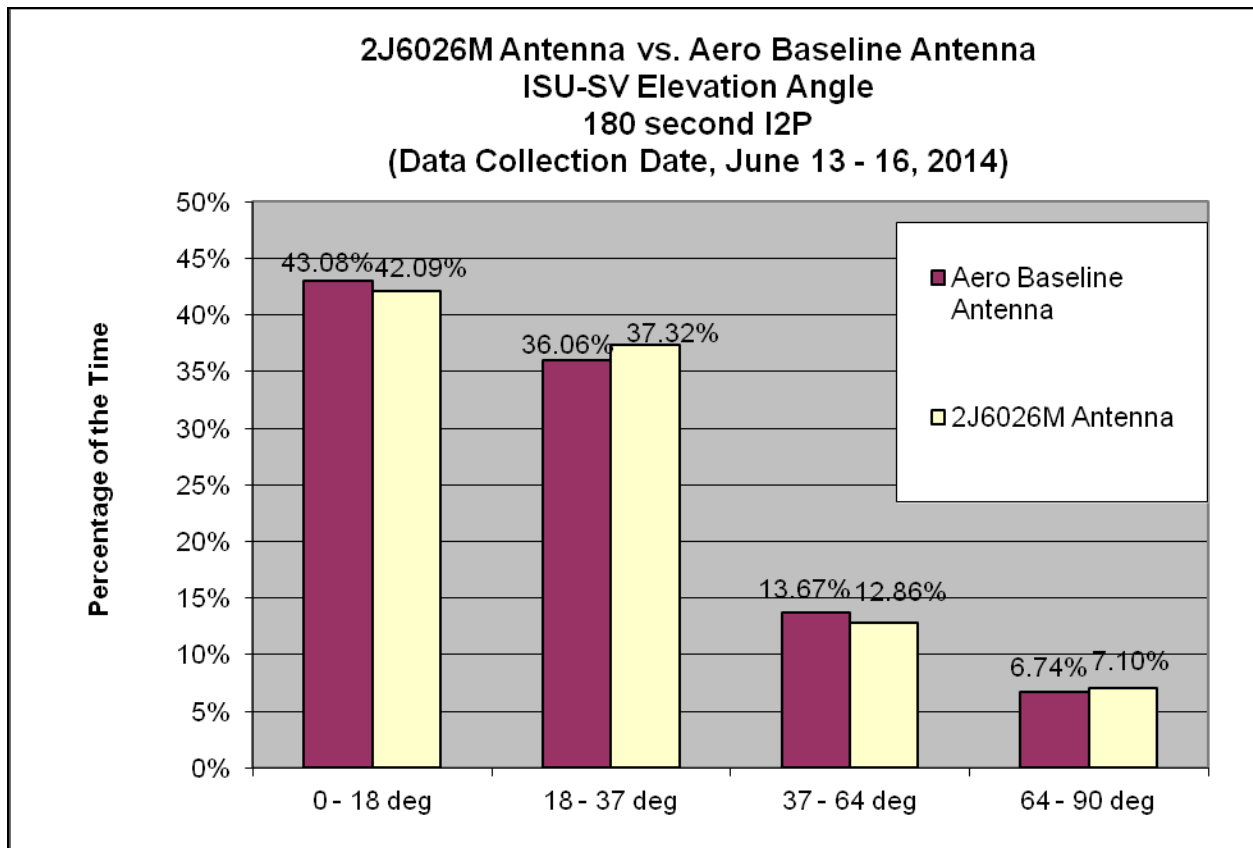

Figure 4.1-1: 2J6026M Antenna, Percentage of Time, 180 sec I2P

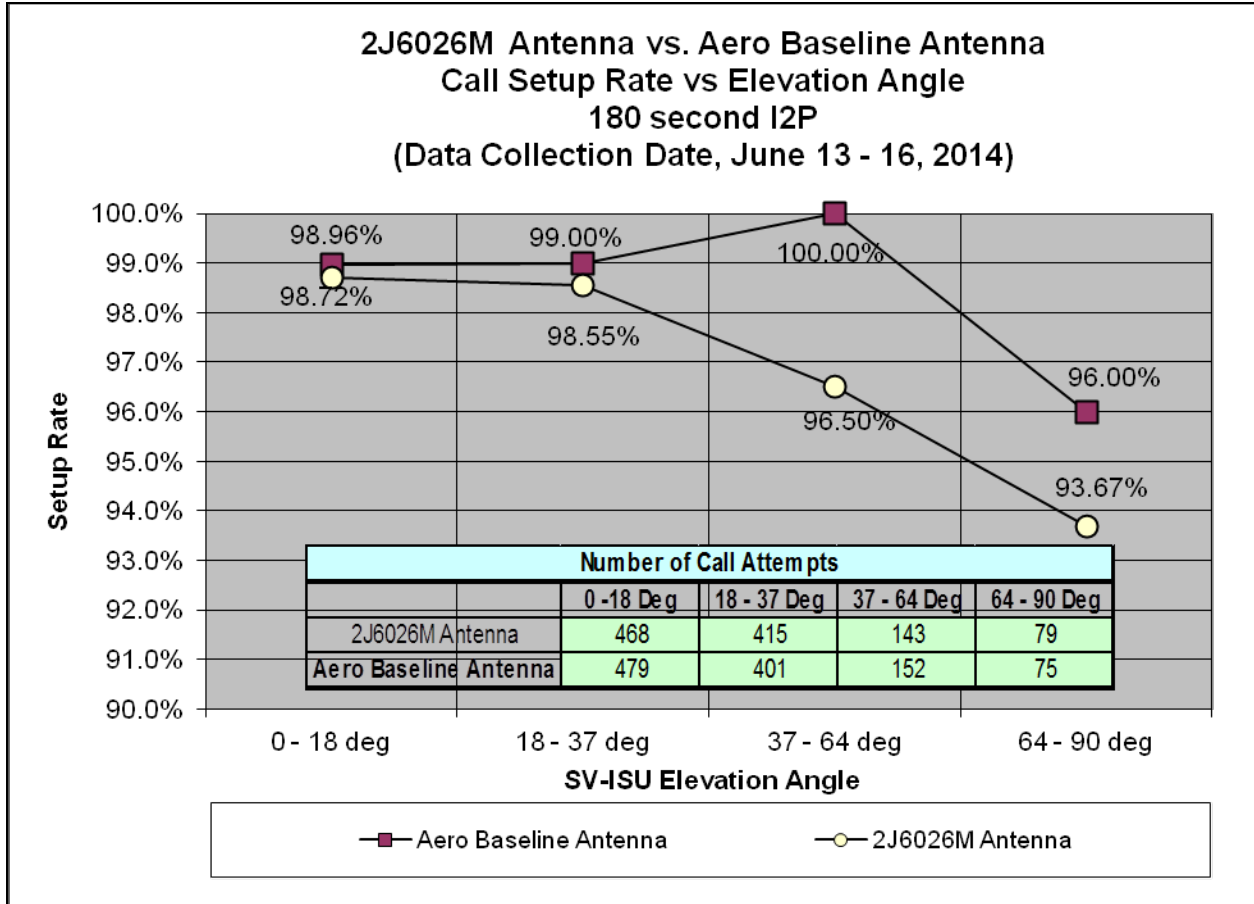

Figure 4.1-2: 2J6026M Antenna, Call Setup Rate vs. Elevation Angle

### 4.2 Data Mode Performance Testing

Data was collected for one day from data calls performing 50k FTP upload transfers.

FTP 50K Upload	Call Attempts	Call Connect Count	Successful Call Connect Rate	Successful Transfer Count	Successful Transfer Rate	Average Throughput (Kb/sec)
2J6026M Antenna	701	650	94.01%	641	91.44%	2.44
Aero Baseline Antenna	736	701	95.24%	682	92.66%	2.65

Table 4.2-1: 2J6026M Antenna, Dialup 50k FTP Upload Testing

#### 4.2.1 Downlink Margin Using Analysis Type One

The binary logfile data generated by the LBT during the data calls was used to determine the overall link margin available using the 2J6026M Antenna. Twenty-four hours of binary logdata was processed to determine the average downlink margin. The results of the test analysis are shown in figures 4.2.1-1 and 4.2.1-2.

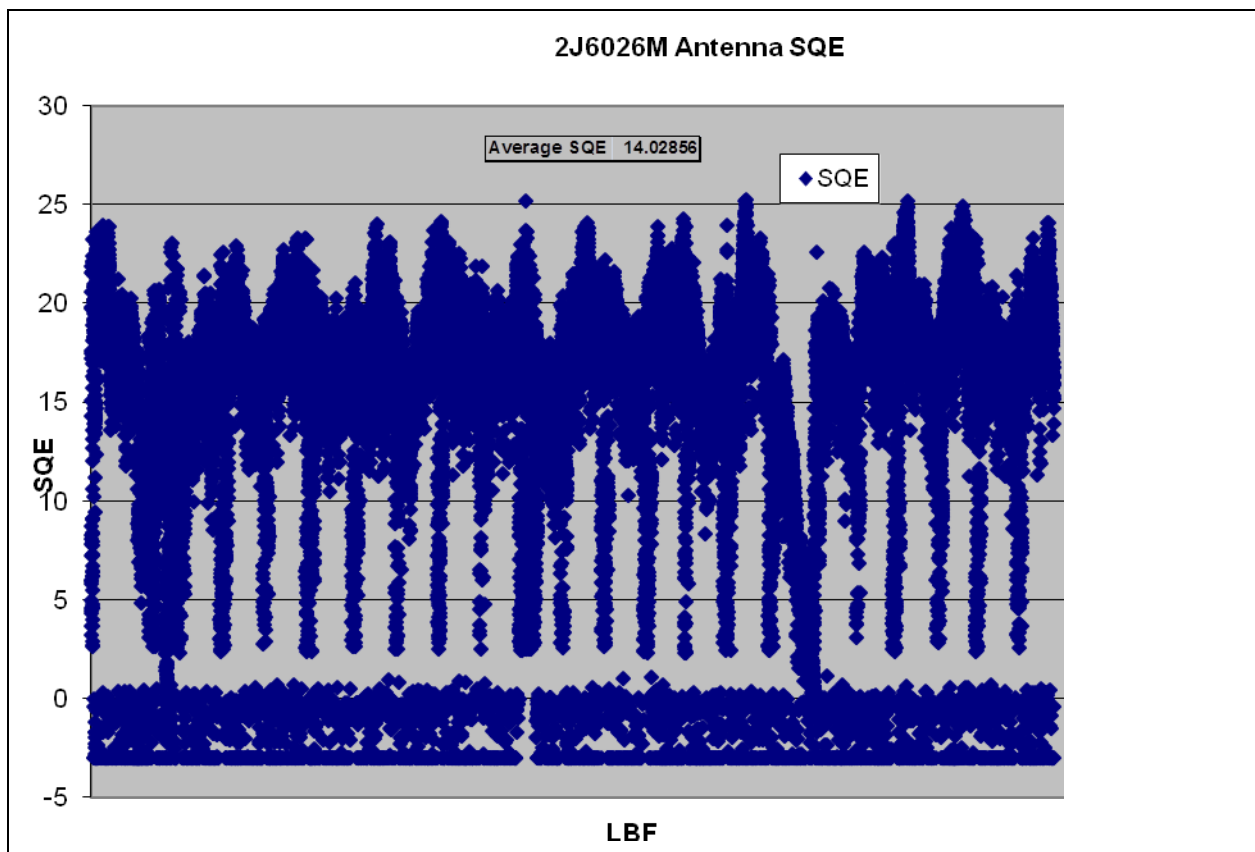

Figure 4.2.1-1: 2J6026M Antenna, Downlink Margin

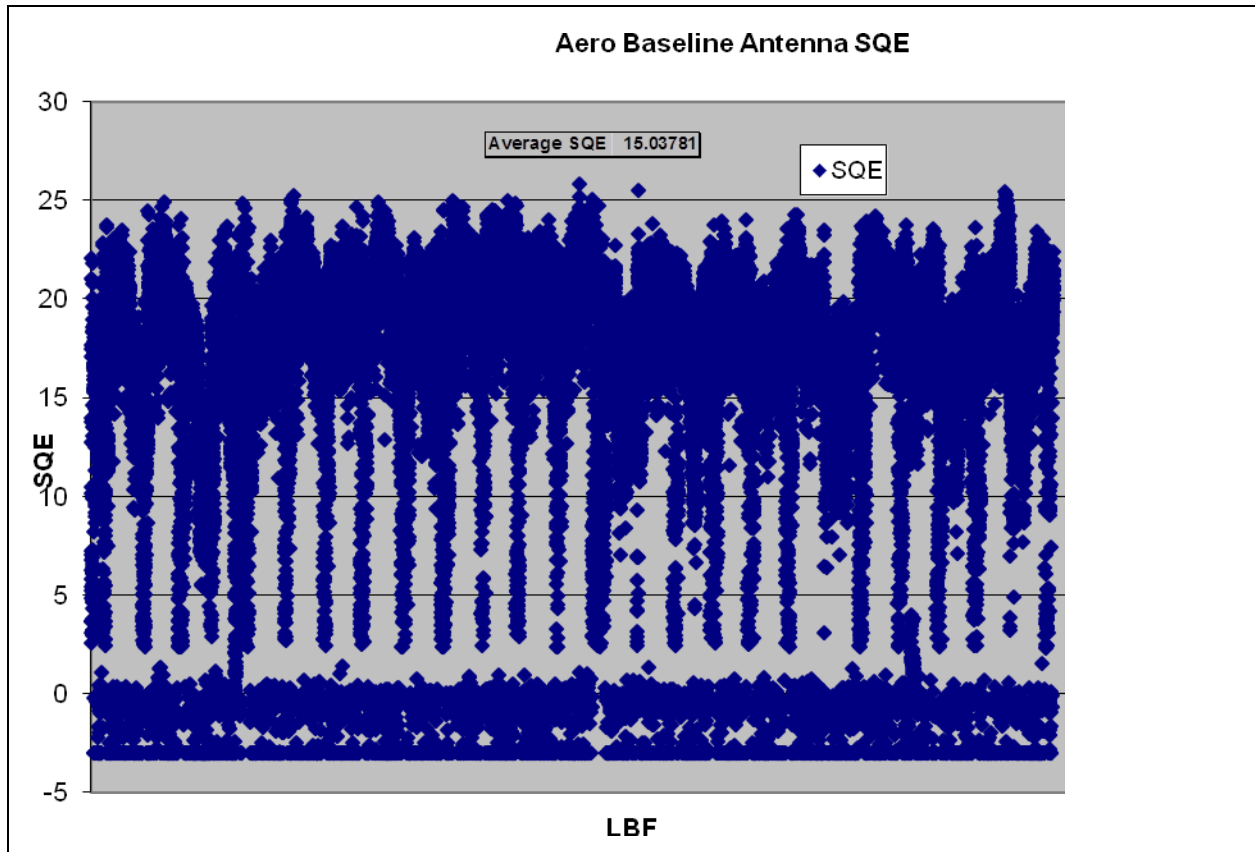

Figure 4.2.1-2: Aero Baseline Antenna, Downlink Margin

4.2.2 Downlink Margin Using Analysis Type Two

Figures 4.2.2-1 and 4.2.2-2 depict the link margin on a per beam basis, evaluating only the traffic channel and does not include values that are 0 db or less.

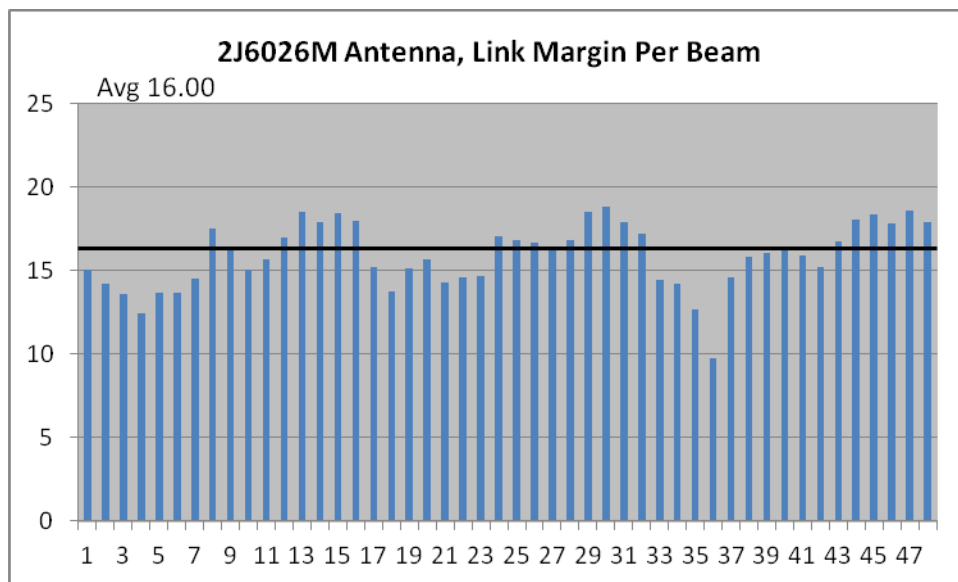
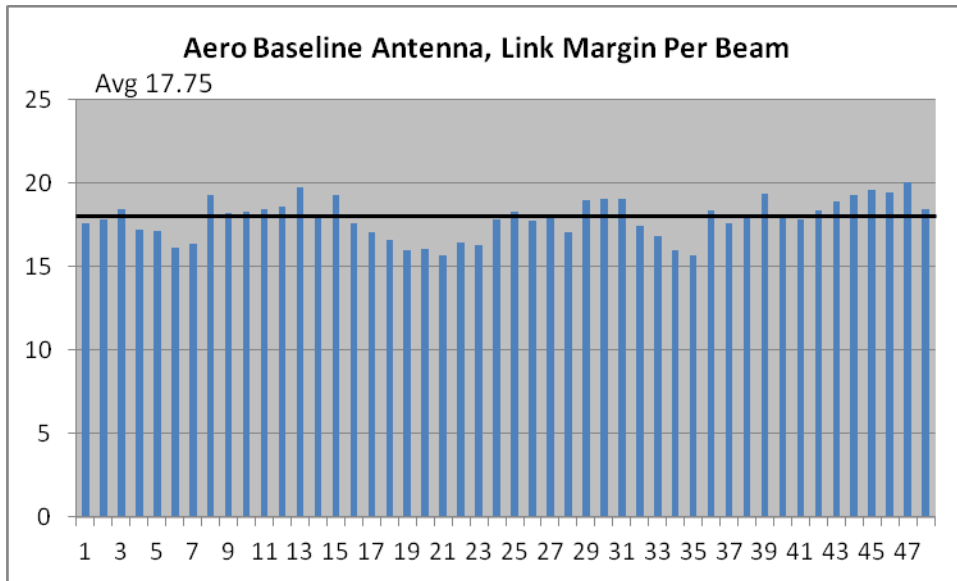

Figure 4.2.2-1: 2J6026M Antenna, per Beam Downlink Margin



*Figure 4.2.2-2: Aero Baseline Antenna, per Beam Downlink Margin*

### 4.3 Power Control Efficiency

The binary logfile data generated by the LBT during 180 sec I2P voice calls was used to determine the SV-ISU power control efficiency. Twenty-four hours of data was processed to determine the efficiency of the power control system.

#### 4.3.1 Power Control Capacity Factor

The results are presented in terms of Capacity Factor (Figure 4.3.1-1), which is a ratio of voice call power to full power. Capacity Factor is calculated by determining the amount of time spent at various power levels during uplink and downlink.

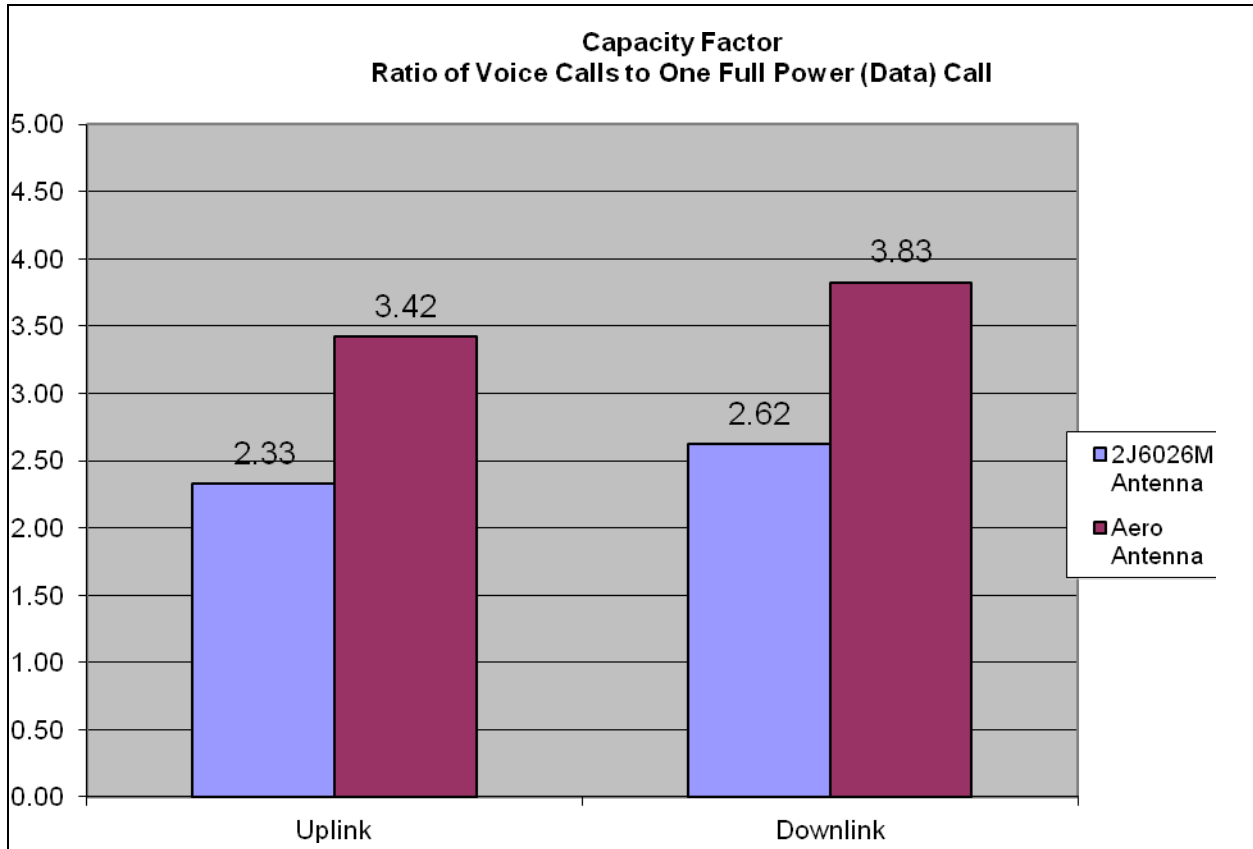

Figure 4.3.1-1: 2J6026M Antenna, Capacity Factor during 180 second I2P Voice calls

Another view of the percentage of time spent at each back-off power level is depicted in figures 4.3.1-2 and 4.3.1-3. The graph shows how the antennas cause the SV to spend time at different power levels.

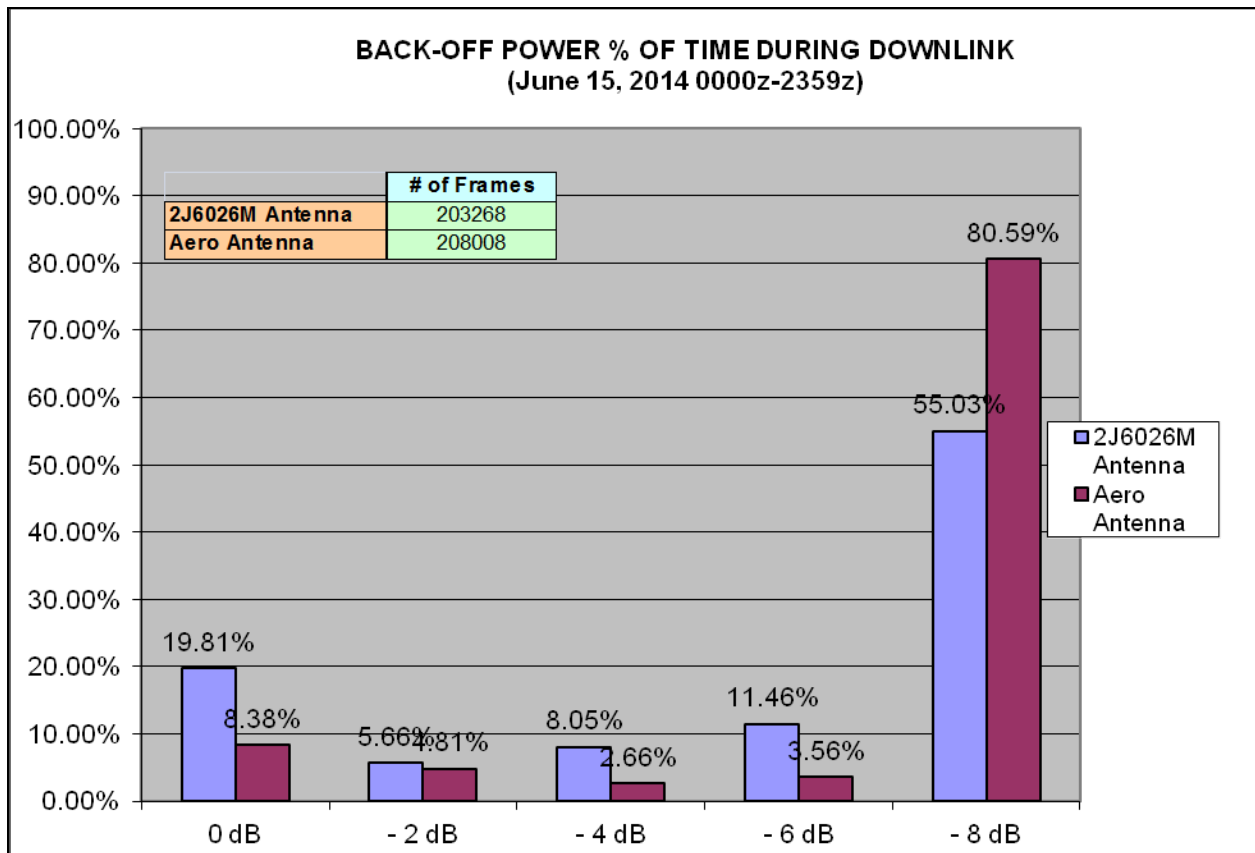

Figure 4.3.1-2: 2J6026M Antenna, Downlink, Back Off Power Percentage of Time



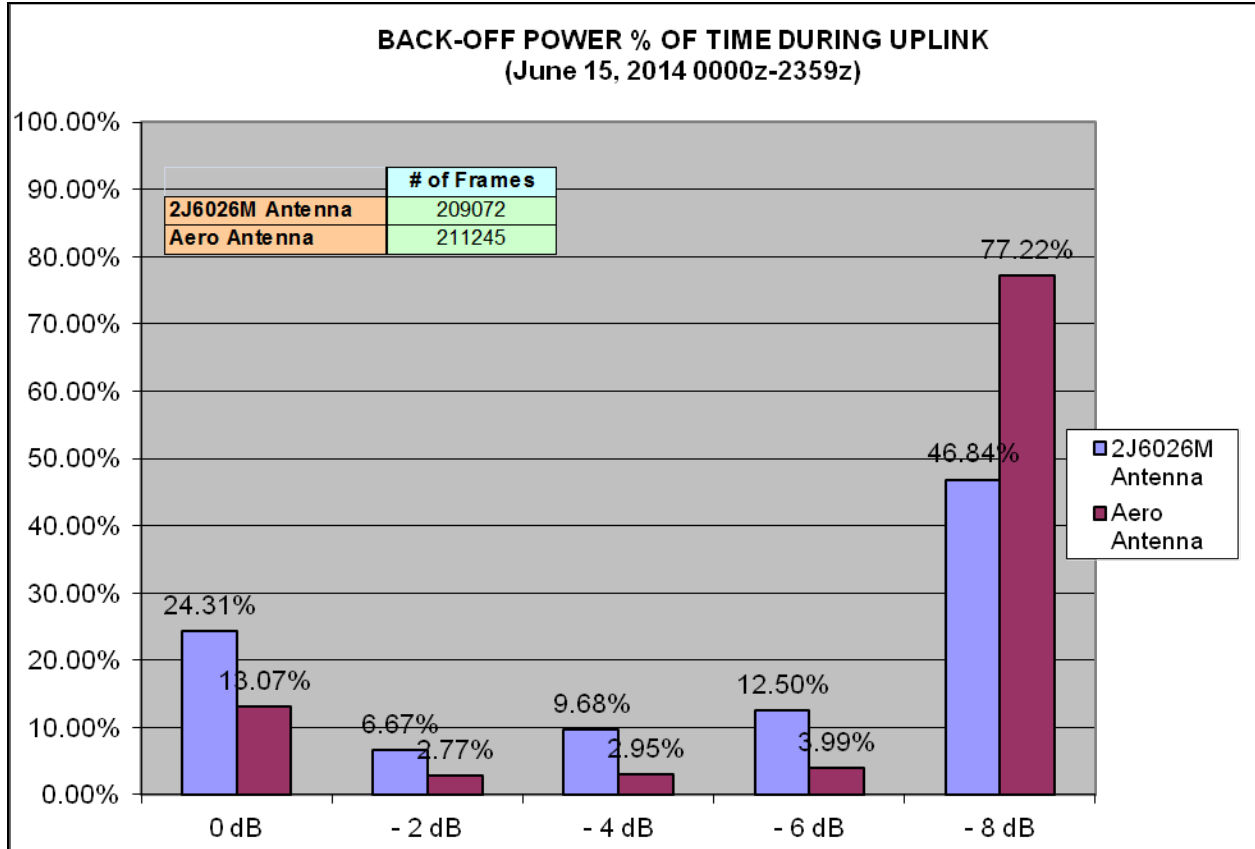

Figure 4.3.1-3: 2J6026M Antenna, Uplink, Back Off Power Percentage of Time

4.3.2 Power Control Link Quality Index and Power Control

Figures 4.3.2-1 through 4.3.2-4 show Link Quality Index and the Power control settings, for both uplink and downlink for voice calls.

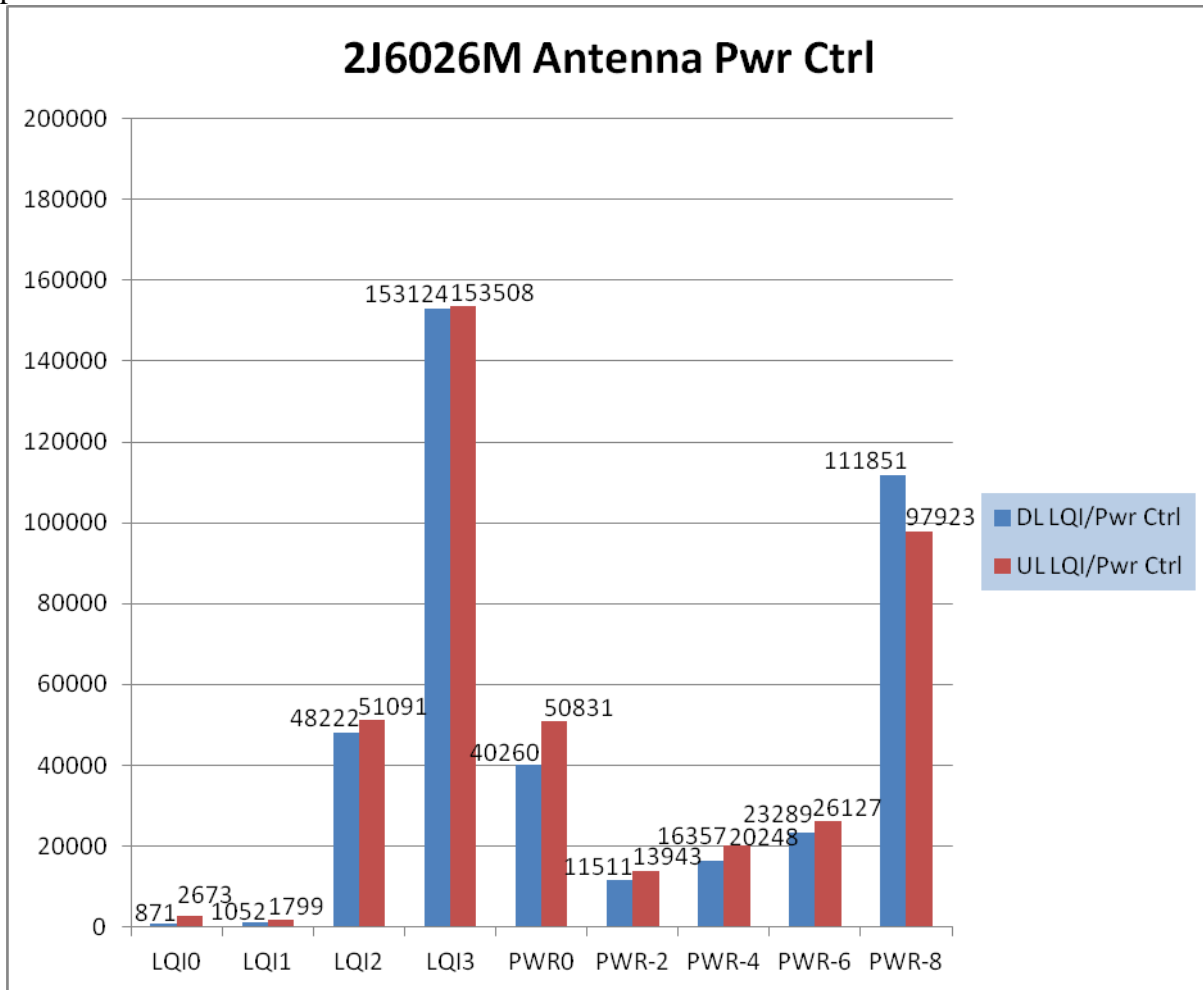
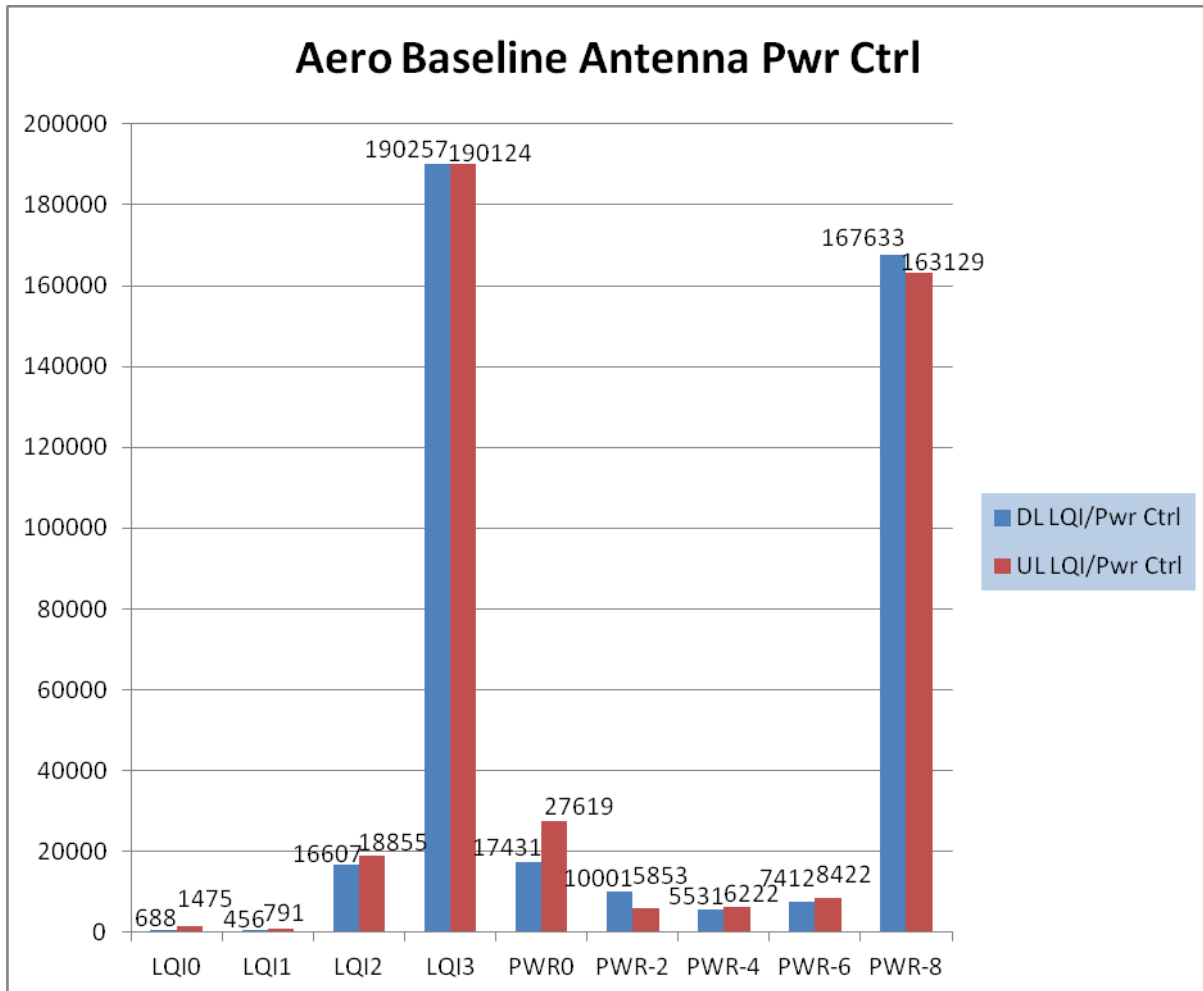

Figure 4.3.2-1: 2J6026M Antenna, LQI and Power Control 180 Sec I2P



*Figure 4.3.2-2: Aero Baseline Antenna LQI and Power Control 180 Sec I2P*

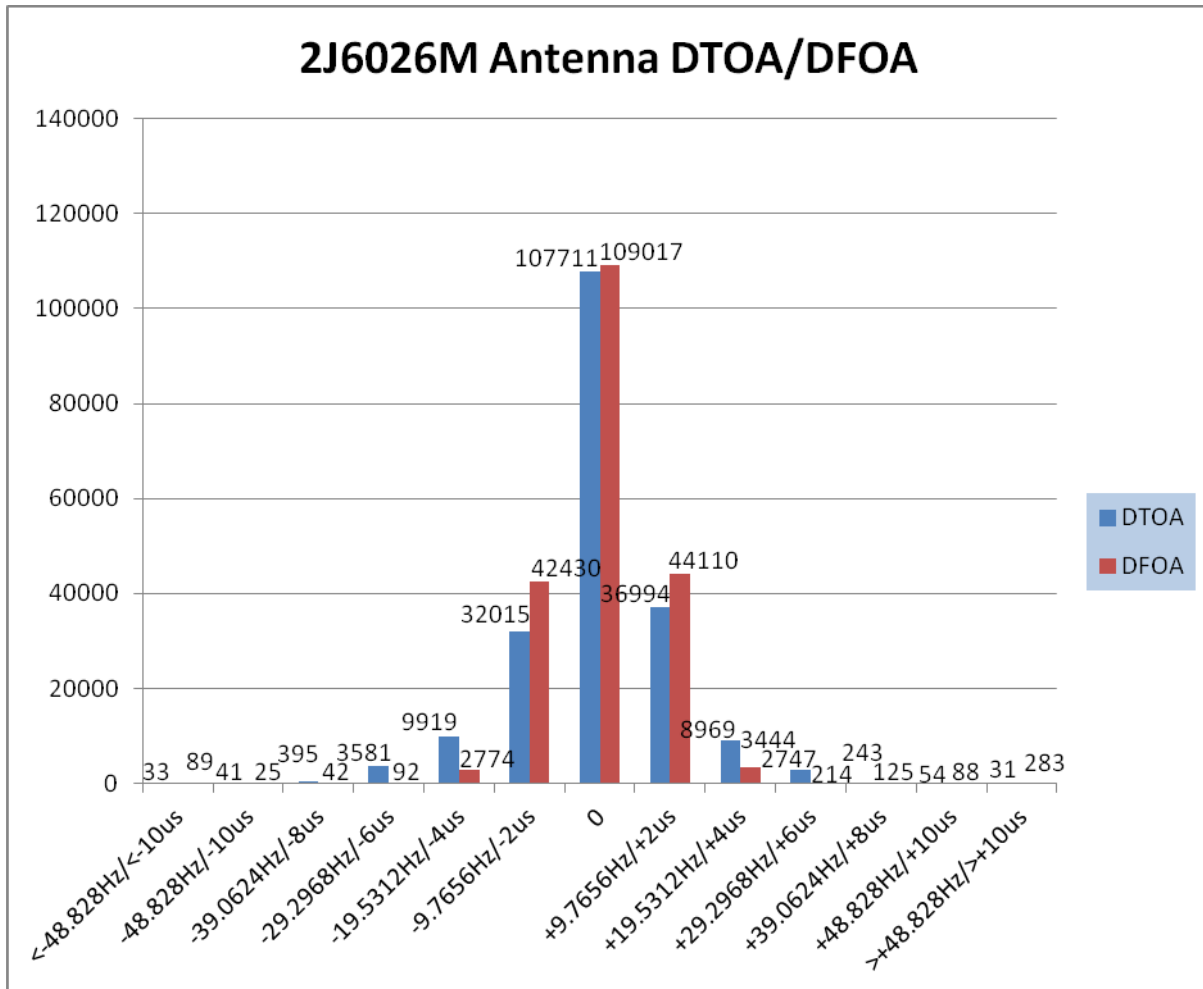

Figure 4.3.2-3: 2J6026M Antenna, DTOA/DFOA, 180 Sec I2P

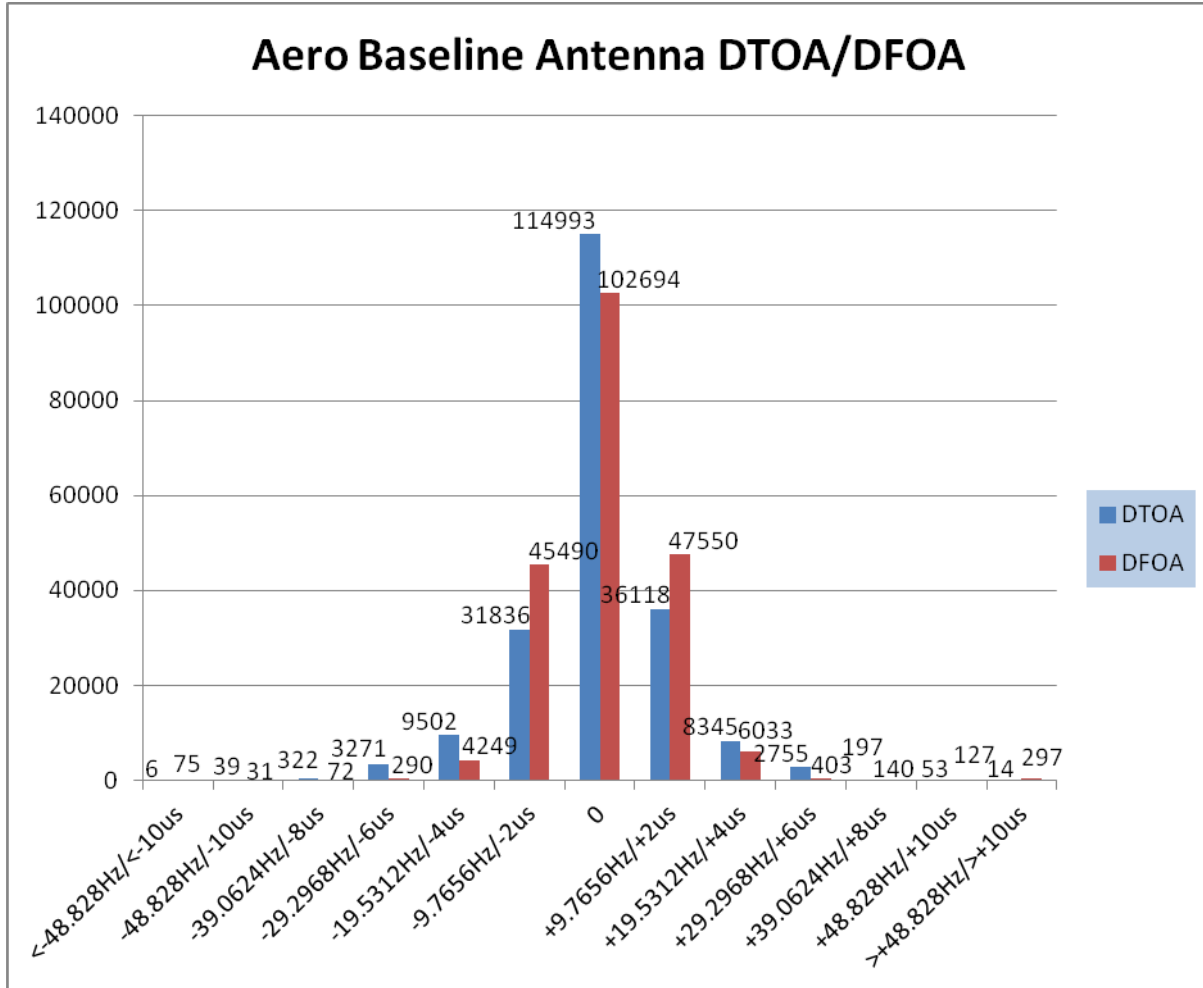

Figure 4.3.2-4: Aero Baseline Antenna, DTOA/DFOA, 180 Sec I2P

## 5. TEST SUMMARY

### 5.1 Voice Calls

The 2J6026M Antenna voice call setup success rate is 1.08% lower and the call drop rate is 0.11% higher compared to the Aero Baseline Antenna as depicted in Table 4.1-1. Power Control efficiency is shown in Figure 4.3.1-1. The 2J6026M Antenna supports 2.62 voice calls on the downlink and the Aero Baseline Antenna supports 3.83 voice calls on the downlink per full power Traffic Channel. This means that the 2J6026M antenna requires 32% more power on the SV downlink on average than the Aero Baseline antenna.

### 5.2 50K FTP Upload

The 2J6026M Antenna data call connect success rate is 1.23% lower compared to the Aero Baseline Antenna. The 2J6026M Antenna successful data transfer rate is 1.22% lower than the Aero Baseline Antenna as depicted in Table 4.2-1. . The 2J6026M Antenna average throughput is 2.44 Kb/sec compared to 2.65 Kb/sec for the Aero Baseline Antenna, as shown in Table 4.2-1.

#### 5.2.1 Downlink Margin

Type 1 analysis:

The 2J6026M Antenna link margin is 1.01 db less than the Aero Baseline Antenna as depicted in section 4.2.1.

Type 2 analysis:

The 2J6026M Antenna link margin is 1.75 db less than the Aero Baseline Antenna as depicted in section 4.2.2. The difference between the highest beam power and the lowest beam power for the 2J6026M antenna is 9.05 db while the difference between high and low beam power for the baseline antenna is 4.40 dB.